

Unic
Jávea



aedashomes.com



Edition and design: AEDAS Homes

Dossier: The images shown are the closest possible portrayal of the final result of the planned property, although there may be modifications derived from technical or legal requirements, provided they are justified and do not represent a material alteration of the object and/or quality of the materials. The furniture shown is not included and the fittings included with the property are as indicated in the building specifications. All information provided and documentation supplied will be compliant with Royal Decree 515/1989, of the 21 April, and any other supplementary rules, be they of a state or regional nature.

Building specifications: The images shown are as close a portrayal as possible of the final result of the projected property with the specifications indicated herein; however, modifications may occur due to technical or legal requirements, provided that such are justified and do not involve a substantial alteration of the object and/or a decrease in the quality of the materials/equipment of the property. The furniture shown is not included. All information and documentation will be provided in accordance with the provisions of Royal Decree 515/1989, of 21 April, and other complementary regulations, whether of a state or regional nature.

© 2023

Unic

Jávea



Our commitment with you begins right from the outset, so we want to share your new home's building specifications with you. Find out all the details about Unic and begin to imagine the spaces that will, in no time, become a dream come true.

Welcome

Dossier

01 **Why Unic in Jávea?**

The home you are looking for
This is what living in Jávea is like
Perfect communications

02 **Places for getting away from it all**

03 **Elegance and avant-garde**

The light and warmth you need
Cosy, top-quality spaces
A home for every type of family

04 **Energy efficiency always in mind**

Building specifications

01 **A unique estate**

Entrances
Community space

02 **Your home**

Hallway, living room, passageway and bedrooms
Kitchen
Select service
Living service
Bathrooms
Terraces
Interior walling and insulation
Interior carpentry

03 **Installations**

Plumbing and drains
Heating/air-conditioning
Electricity/Telecommunications
Common elements
Structure and foundations
Sustainability measures of your promotion

Reasons for placing your trust in us



Dossier

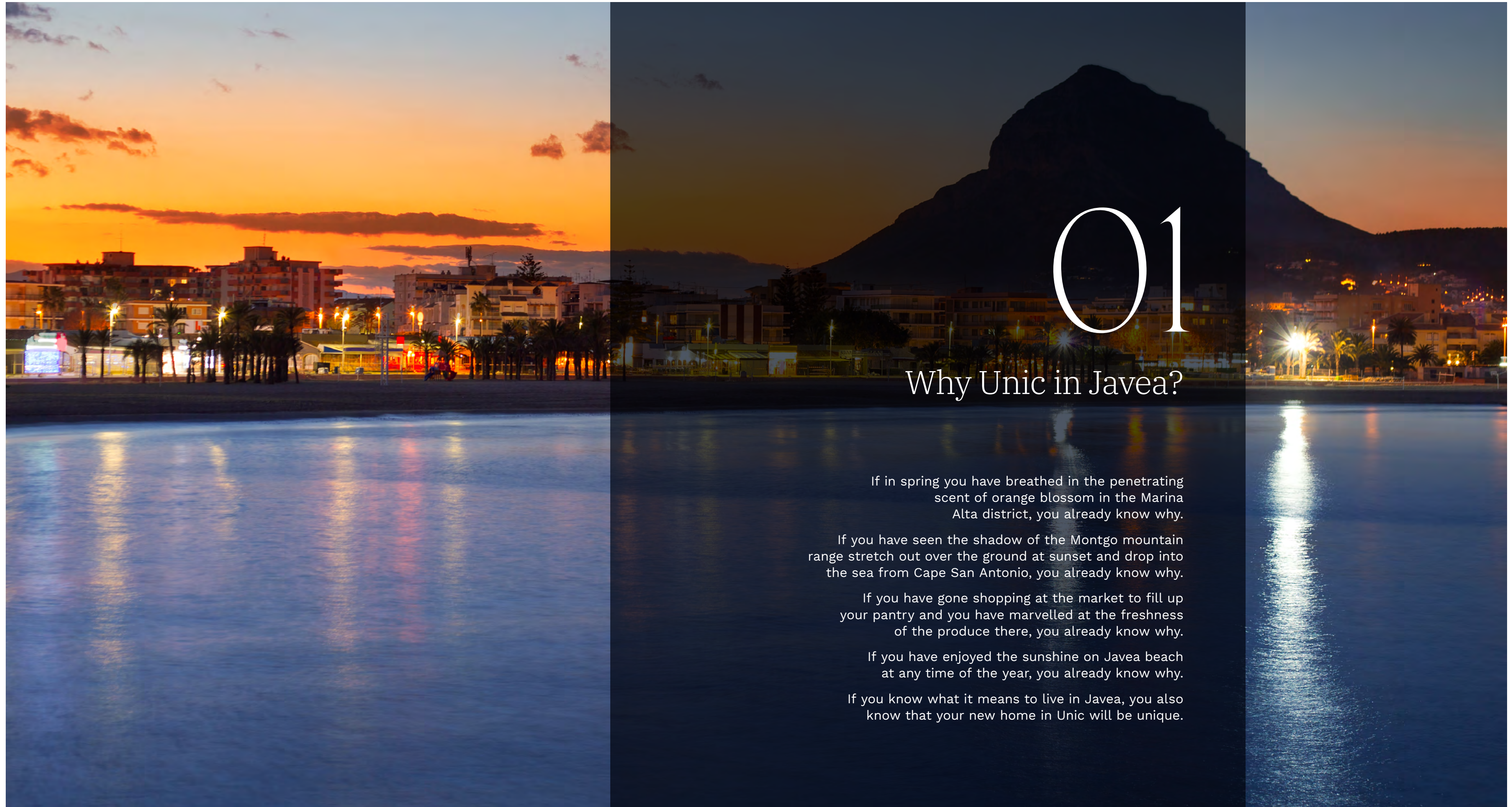

01

Why Unic in Jávea?

If in spring you have breathed in the penetrating scent of orange blossom in the Marina Alta district, you already know why.

If you have seen the shadow of the Montgo mountain range stretch out over the ground at sunset and drop into the sea from Cape San Antonio, you already know why.

If you have gone shopping at the market to fill up your pantry and you have marvelled at the freshness of the produce there, you already know why.

If you have enjoyed the sunshine on Jávea beach at any time of the year, you already know why.

If you know what it means to live in Jávea, you also know that your new home in Unic will be unique.



The home you are looking for

We know the home you are looking for is like you: It has your personality, that way of perceiving life that is so particular and a touch of singularity that makes it a space just for you. That is why at AEDAS Homes we are offering you an exclusive complex of 1-, 2-, 3- and 4 bedroom homes, including a choice of ground floor dwellings with their own gardens, upper storey flats and duplex apartments with large terraces, all including a garage parking space and boxroom.

This is what living in Jávea is like

Forming part of a model Mediterranean town, Unic stands in a municipality committed to quality of life. Jávea is the perfect destination for those seeking a relaxed lifestyle without waiving the convenience of having all the necessary services just around the corner.

Your new neighbourhood, bordering on the west with Parque Reina Sofía square and on the east with Vía Augusta, offers supermarkets, schools, libraries, sports and health centres, all within walking distance. From Unic, moreover, it will only take you 5 minutes to reach the Old Town and harbour, a district with multiple leisure options and a great variety of restaurants.

Unic is just a short distance from Montañar beach, a perfect spot for practising water sports. If you prefer golf, you can perfect your swing on the various courses in the Jávea area.





Perfect communications

Your new home is situated in a very well communicated sector. From there, taking routes such as the CV-734, you will enjoy easy access to the AP-7 motorway or the N-322 highway, meaning you can swiftly reach other towns in the area, such as Oliva, Calpe or Gandía, without having to allow for a long commute.

If you prefer to leave your car parked at home, Jávea bus station is just 10 minutes away..



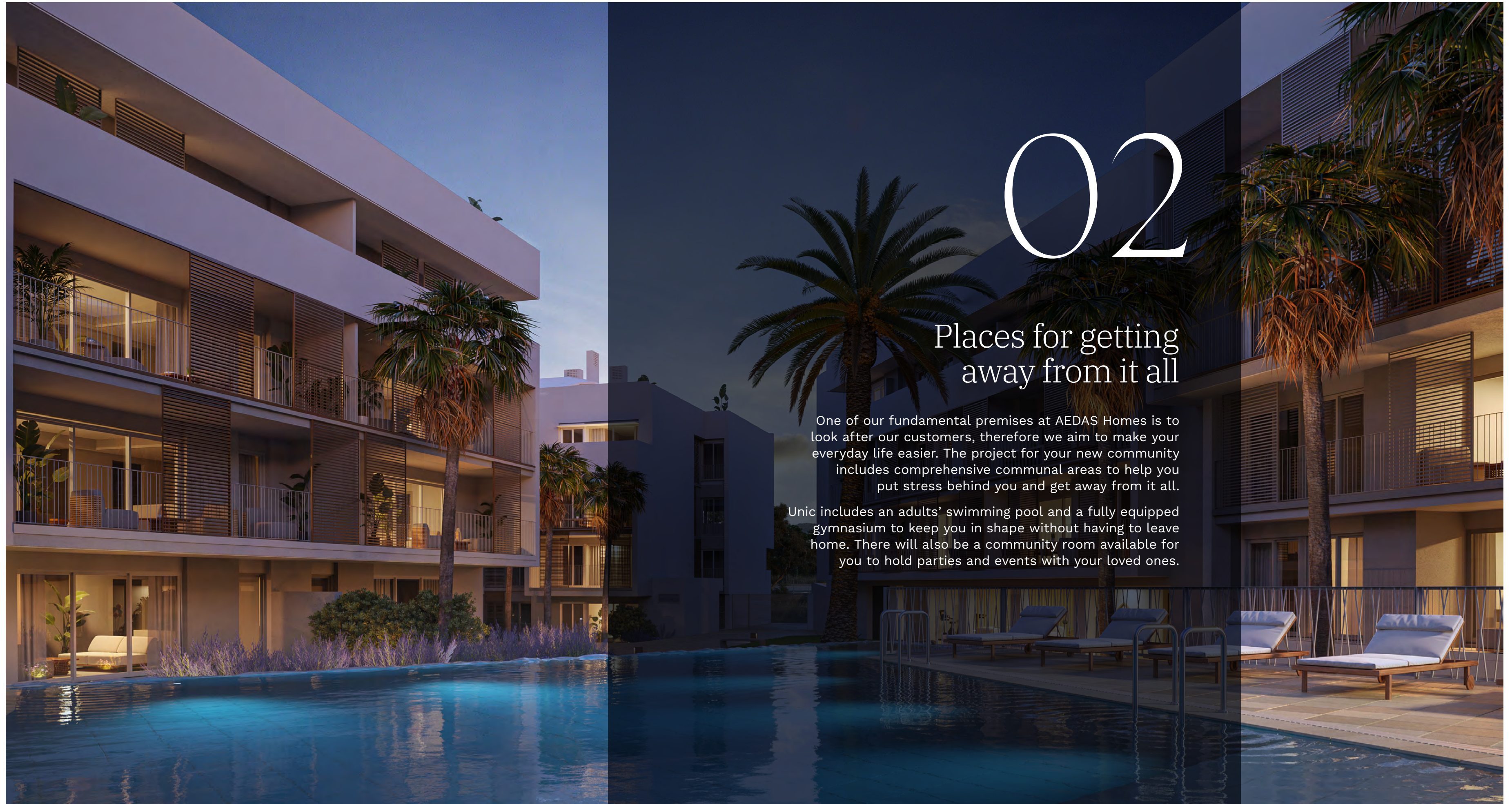

02

Places for getting away from it all

One of our fundamental premises at AEDAS Homes is to look after our customers, therefore we aim to make your everyday life easier. The project for your new community includes comprehensive communal areas to help you put stress behind you and get away from it all.

Unic includes an adults' swimming pool and a fully equipped gymnasium to keep you in shape without having to leave home. There will also be a community room available for you to hold parties and events with your loved ones.



03

Elegance and avant garde

Given that such attention to detail is paid in our interiors, the exteriors can warrant no less. Merging to perfection avant-garde trends and the timeless elegance of more classical constructions, the aesthetic beauty of the building lies in its façade through textures and colours that blend in with the surroundings.

All with the seal of quality of Maíz+Herrada Arquitectos so that you can boast of having a home signed by a multi prize-winning studio (including the National Prize for Housing Quality, awarded by the Ministry of Transport, Mobility and Urban Agenda)-.

At just one glance, Unic makes you feel proud of your new home and its location.

Who said beauty is only on the inside?



The light and warmth you need

To enjoy the backdrop of where you are going to live (with the Montgo Natural Park and the Mediterranean as the outstanding features), at AEDAS Homes we have projected spacious terraces in all the dwellings. In the duplex apartments, these open-air spaces may come to exceed 30 m².

In Unic, light spreads easily and unhindered in a perspective offering a clear eyeline in each of the rooms.

Cosy, top-quality spaces

Your home is conceived for you to live unlimited experiences. Because we know you like to get home and enjoy it, all the rooms in your dwelling are designed so that you feel enveloped in their comfort, surrounded by high-end specifications. Unbeatable finishes and materials are an essential part of your new home; whilst you rest in your bedroom or prepare your favourite dishes, you will enjoy an experience based on the comfort and harmony of its different rooms.

A home for every type of family

Both families that are beginning to grow and those already consolidated will find their ideal home in Unic. Take a look at the plans which best match your tastes and preferences and choose the one that is destined to be your future home. We have ground floor units with their own garden, duplex apartments or upper storey flats available for you.



“Unic’s design endows the dwellings with special light, thanks to the latticework and the terraces which stretch the home interiors out into the marvellous outdoor setting of Jávea”

Maíz + Herrada, architects.





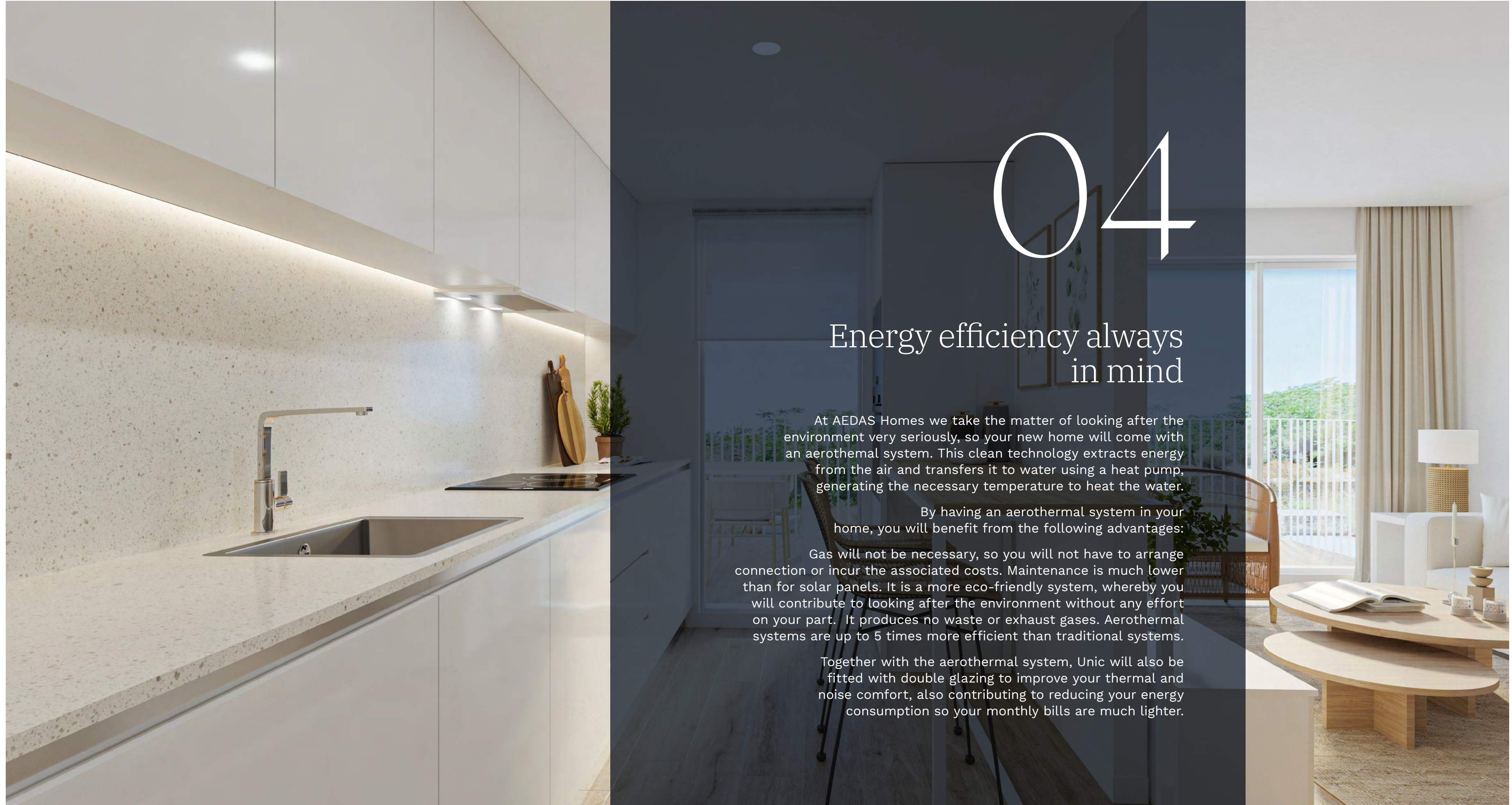

04

Energy efficiency always in mind







At AEDAS Homes we take the matter of looking after the environment very seriously, so your new home will come with an aérothermal system. This clean technology extracts energy from the air and transfers it to water using a heat pump, generating the necessary temperature to heat the water.

By having an aérothermal system in your home, you will benefit from the following advantages:

Gas will not be necessary, so you will not have to arrange connection or incur the associated costs. Maintenance is much lower than for solar panels. It is a more eco-friendly system, whereby you will contribute to looking after the environment without any effort on your part. It produces no waste or exhaust gases. Aérothermal systems are up to 5 times more efficient than traditional systems.

Together with the aérothermal system, Unic will also be fitted with double glazing to improve your thermal and noise comfort, also contributing to reducing your energy consumption so your monthly bills are much lighter.



-  **Lighting**
Large-format windows to favour natural light.
-  **Thermal quality**
Thermally insulated façades.
-  **User manual**
Guidance on efficient use of the building.
-  **Innovation**
Smart dual-flow ventilation with heat recovery system.
-  **Renewable energies**
Aerothermal for the production of sanitary hot water. Air conditioning by ducts.
-  **Sustainable transport**
Preinstallation of charging point for electric vehicles.
-  **Noise insulation**
With the outside, in interior partitioning and between dwellings.



+ SAVING

Lower consumption and less maintenance.

+ WELLNESS

Thermal, acoustic and lighting comfort.

+ VALUE

Increased value of the property.

- CONSUMPTION

Savings on utility bills.

- NOISE

Improved sound insulation.

- CO₂

Lower emissions to protect our planet.



Building Specifications

01

A unique estate











At AEDAS Homes, quality is our hallmark and an ever-present objective, hence we have put great thought into all the details of your new home.

Entrances

The indoor communal area at Unic will come with ceramic tile flooring and walls combining different materials depending on the zone.

Technology will be present via lighting triggered by movement detectors depending on the areas and floors, which optimises the use and consumption of resources and results in important savings in monthly energy bills.

The elevators will to all house access floors and the elevator cars will be finished in accordance with the rest of the project and be sized to meet Accessibility Regulations. They will have automatic, stainless steel doors and be fitted with alarms and a telephone service for emergencies.

-  Community swimming pool.
-  Community garden.
-  Solarium beside the pool.
-  Boxroom.
-  Community room.
-  Residents' car park.
-  Gymnasium.
-  Accessibility ramps.
-  Bicycle storage facility.

Community space

Your community will make you feel proud of your new home even before you go inside.

The development will include a swimming pool, community room, toilet facilities, a gymnasium, garden, residents' car park and boxrooms, all for you to share unforgettable moments with your loved ones.



02

Your home



Hallway, living room, passageway and bedrooms

Your home will be paved throughout in porcelain stoneware.

All the walls and ceilings will come in a plain emulsion paint finish in a light colour shade.

Kitchen

Preparing your favourite dishes will be much easier in this space we have designed for you. These are the specifications and finishes included in your new kitchen at Unic:

- › Rectified porcelain stoneware flooring, a finish that will provide optimum resistance to breakage and blows while at the same time achieving a more aesthetic appearance by making the joint grouting virtually invisible.
- › Vertical surfaces in damp-proof drywall with a plain emulsion paint finish.
- › Continuous suspended ceiling finished in plain emulsion paint.

The kitchen will be delivered in a contemporary design with wall units with concealed pull handles and base units with concealed pull handles and a cutlery organiser (all high capacity) and it will also include the following fittings and appliances:

- › Induction hob.
- › Extractor fan.
- › Conventional and microwave ovens.
- › Worktop and backsplash in Neolith or similar
- › Stainless steel sink mounted under the worktop with swivel-neck mono mixer tapware.



Select service

With the AEDAS Homes Select Service, you will be able to customise certain aspects of your new home:

- › Choose between different ambiances depending on your tastes.
- › Adapt the kitchen and lounge spaces in your home so they best meet your needs.
- › Increase your comfort levels with safety devices and applied technology.
- › Improve the building specifications and finishes.

Select

Living

We also offer you Living, the AEDAS Homes interior design service, with which you can start to enjoy your home from the day you move in. You will have a team of professionals at your disposal who will convert the different spaces into the home of your dreams.





Bathrooms

The walls of the en suite bathrooms will be tiled in highly resistant rectified porcelain stoneware. Secondary bathrooms and washrooms (in homes where such are included) will come in a rectified white clay ceramic tile finish.

Floors will be in large size porcelain stoneware, capable of withstanding blows and damp thus retaining the properties of the flooring.

All the bathrooms will be fitted with mono mixer taps and the bathroom suites will be a contemporary design in white glazed porcelain.

The master bathroom will be delivered with a large size, extra flat shower tray, thermostatic tapware and a wall-mounted vanity unit with a built-in washbasin, all forming a space that is, in all aspects, aesthetically harmonised. Fixed panel and mirror will also be installed in the master bathroom. In the secondary bathroom, you will find a wall-mounted washbasin and a bathtub, providing the design project allows for such.

All the bathrooms will come with LED light fittings.

Terraces

Todas las terrazas llevarán toma de agua y sistema para To ensure your utmost safety, the terrace in your home will be paved in non-slip stoneware, especially designed for outdoor usage. All the terraces will come with a light fitting and power socket.



Interior walling and insulation

The interior walling employed in your new home will prevent noise transfer and also provide the perfect base for a plain paint finish.

- › Dividing walls between rooms: in drywalling.
- › Dividing walls between dwellings: mixed brick, insulation to Technical Code standard and lined on both sides.
- › Dividing walls between dwellings and communal spaces: built of brick, lined in drywall on both sides and insulated to the inside of the dwelling.

Division between houses

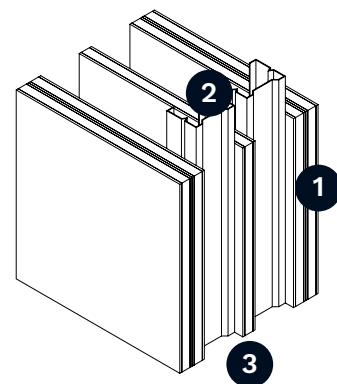

- 1 Laminated gypsum board
- 2 Galvanized steel profile
- 3 Acoustic isolation

Interior carpentry

AEDAS Homes has also paid great attention to the interior carpentry so you can enjoy all the details in your new home.

- › Armoured home entrance door, spyhole and security lock.
- › Interior doors will be in medium density fibre (MDF) with a lacquer finish and steel-coloured handles, giving the dwelling a smart, contemporary appearance.
- › Modular, block-type, built-in wardrobes with lacquered doors. Inside, they will be fitted with a hanging rail and top shelf.
- › Depending on the dwelling version, your new home will also include a cupboard in the hall for greater convenience.



03

Installations



Plumbing and drains

The plumbing installation will include water inlets for each bathroom fitting and kitchen facility (sink), and for the electrical appliances in the kitchen (dishwasher and washing machine). Your home will have a general cut-off valve and individual cut-off valves for each room with plumbing.

All the bathroom fittings and kitchen facilities will be connected to the sewer network. The installation will comply with the specifications of the Basic Noise Protection Document (DB HR) as regards noise emissions. You will have an individual water meter and domestic hot water will be produced using an aerothermal unit.

Heating/cooling system

To ensure you enjoy the utmost comfort, your new home will be fully fitted with a conduit air conditioning (heating/cooling) system with supply grills in the lounge and bedrooms.

Common elements

Façade and roof

The façades in Unic will be built in perforated ceramic brick, finished in plain, synthetic resin mortar, achieving an attractive, contemporary look.

The façade finishes will combine thermal performance with the most avant-garde design, adapted to meet the needs of the 21st century.

The façade will also be internally faced with thermal and noise insulation, which will provide large energy savings and raise the comfort level inside the dwelling.

The inside of your home will be drywall faced.

Exterior carpentry and glazing

- › Aluminium or PVC frame carpentry as per the project design with thermal bridge break, and high thermal and noise protection performances.
- › Glazing with air chamber.
- › Roll-up blinds in bedrooms.

Electricity and telecommunications

Your home will be fitted with the number of power and telecommunications sockets required to meet Low Voltage Electrotechnical Regulations requirements, together with a video door-phone for communication with the main community entrance door.

You will have telephone and TV sockets in the lounge and bedrooms and fibre optic cable will be installed to your home.

Structure and foundations

Your new home will have a reinforced concrete structure calculated compliant with Earthquake-resistant Construction Regulations. The entire structure will be calculated to current regulatory standards and the Technical Building Code.

The foundations will be projected as per the conclusions of the Geotechnical Survey.

Exterior carpentry

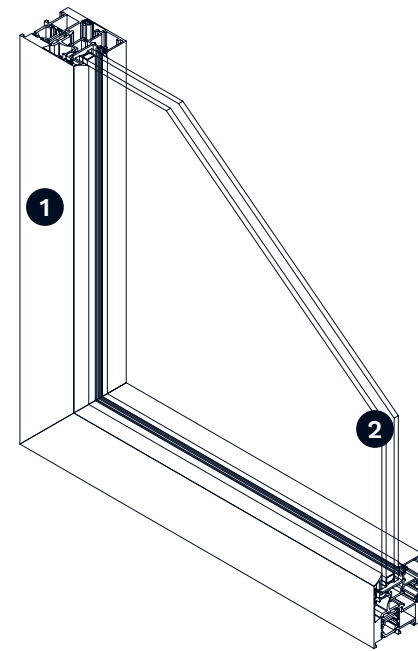

- 1 Aluminium or PVC frame carpentry as per the project design with thermal bridge break.
- 2 Double-glazing with air chamber.

Sustainability measures of your promotion

Aerothermal System

Domestic hot water will be produced using an aerothermal heat pump, a system that harnesses the thermal energy present in the air and transfers it inside the dwelling to provide domestic hot water. An aerothermal heat pump is efficient and sustainable technology which produces significant energy savings and reduces direct CO₂ emissions.

In addition to the environmental benefits, you will also notice you will receive significantly lower energy bills. Approximately 60% of the heat produced by aerothermal energy is considered renewable energy, coming from the energy exchange with the outside air, and therefore, it will not cost you anything.

Check all the sustainability measures of Unic in your Ecoliving document.



Reasons for placing your trust in us

With you from the very first. At AEDAS Homes, our professionals deeply share our company's values and they attend your home as if it were their own. Integrity, excellence, transparency and innovation are the cornerstones of the service you receive when you choose us. Our highly qualified team has vast training and experience in the world of residential developments and this translates into an unwavering commitment to you.

When you choose an AEDAS Homes dwelling, not only are you opting for top quality specifications and avant-garde architecture, you are also committing to looking after the environment. Environmental protection is one of our great proposals, and in all our projects our commitment to rational use of natural resources and the employment of efficient systems resulting in energy savings are both quite evident.

At AEDAS Homes we know that sustainability and design are not at odds with each other and hence we have achieved "green" homes that include state-of-the-art innovation in their interior. We apply avant-garde technology to make your life much more comfortable and in tune with 21st-century requirements



aedashomes.com

Promoción

Avda. Rey Juan Carlos I
Sector Roig Roquetes 1
03730 Jávea (Alicante)

Oficina de venta

Avenida Ausiàs March, 9, bajo
03730 Jávea (Alicante)
T. +34 965 641 716

Oficina de venta

Calle de Padilla, 17
28006 Madrid

